

CEPRO®

LEADING IN WELDING SAFETY

CATALOGUE **WELDING SCREENS**



TABLE OF CONTENTS

General information	3
Standard	4
Robusto welding screen	5
Omnium welding screen	10
Sprint welding screen	16
Gazelle welding screen	18

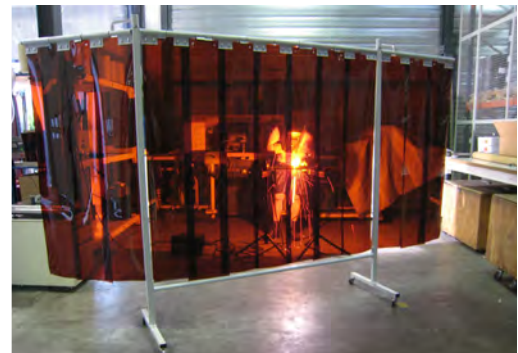

GENERAL INFORMATION

► Protection

Designing a good workplace for welders and grinders and preventing risks are the primary prerequisites for any company or organization involved in professional welding. In addition to these social and humane aspects, there are also factors such as, reducing injuries and sickness absence of welders and other workers, reducing fire hazard and the potential loss of production due to damage, which should be taken into account. Optimum protection of workers against the risks involving welding light, noise and heat are essential for responsible management.

CEPRO are specialists in designing safe welding and grinding work areas and can provide a comprehensive range of products and services. CEPRO products not only increase the safety of the working area, but they also increase efficiency resulting in an improved workflow and cost-savings.

CEPRO products are the result of years of experience in the design and equipping of safe welding and grinding work areas. Our products comply with all the currently applicable standards and regulations, including several subfields.

This brochure elaborates on the various risks associated with the harmful effects of welding light for which CEPRO systems and products can provide you with solutions. Our team at CEPRO have years of experience and know-how to help you and are at your disposal without any obligation. Feel free to contact us for more information.

► Welding screens

The main dangers of unprotected exposure to welding light are: arc eye (during short-term exposure), cataract (by prolonged exposure) and skin burn. The latter can also lead to skin cancer. The welder protects himself by wearing a welding mask and protective clothing but bystanders are exposed to the same dangers. This is why it is important to protect bystanders in the work place to prevent long-term illness.

When protecting the welding area, it is important not to isolate it from other work areas which is one of the reasons why a welding curtain should be made of transparent material. This not only helps to keep an

overview of the work progress, but also allows for a quick response in the case of emergencies. It also prevents the welder from suffering from claustrophobia.

In addition to a wide-range of other products, CEPRO can also provide the necessary materials to construct a welding booth as a permanent fixture.

We can also supply a mobile welding booth which is suitable and easier to move to different locations. Not only do these booths provide protection but they also offer flexibility for organizing workspace. They provide an optimal solution because they can be quickly dismantled and removed from the work floor when welding work is not being carried out.

The CEPRO welding screens programme is divided into 4 product groups which are suitable for various applications.

- CEPRO Robusto welding screens
- CEPRO Omnium welding screens
- CEPRO Sprint welding screens
- CEPRO Gazelle welding screens

You can find the specific properties of each of the different types of CEPRO welding screens at the beginning of every section in this brochure.

STANDARD

In Europe, all welding curtains, strips and other products for the protection of welding areas using transparent materials, must meet the European standard: EN-1598. This standard was last revised in 2012.

The EN-1598 standard determines compliance in the area of:

Filtration

Filtration of harmful ultraviolet (UV) rays and barely visible blue light:

- elimination of UV rays between 210 and 313 nm
- almost entirely filter UV rays between 313 and 400 nm
- filter out blue light on a gradual scale (between 400 and 600 nm)
- restricted filtration of visible light (600 to 1400 nm).

UV reflection

Welding light projected onto a welding curtain can be reflected to a maximum of 10 per cent. This prevents the welder from being exposed to the dangers of UV rays reflected via the welding curtain.

UV stability

Materials can discolour due to exposure to UV radiation, such as in the case of sunlight. The discolouration of a welding curtain directly influences its filtering properties. The EN-1598 stipulates the minimum requirements for protection. A CEPRO approved product provides long-term filtration properties.

Flame retardant

Should a welding curtain catch fire it will self-extinguish once the material has been removed from the heat source. During a test method a piece of curtain 190 x 90mm is exposed to a flame for 15 seconds. If the curtain catches fire, it should self-extinguish within 3 seconds and the flame should not exceed a height of 150mm.

Mechanical strength

On CEPRO's initiative, standards have also been set for the mechanical strength of welding curtains.

Under the stipulated conditions, the suspension eyelets and seams are strong enough to withstand a weight of 7 kilos.

Marking

An approved curtain must indicate the following:

- Name and registration number of the manufacturer (in our case that of CEPRO)
- EN-1589 marking
- Month and year of production
- Approval marking

CEPRO curtains have the certification logo of the reputable DIN-Institute (see below)

DIN certification

CEPRO is one of the few manufacturers that submits its products to the rigorous certification demands of the German DIN Institute for Standardisation.

In this certification procedure, our products are subject to annual re-examinations and the certificate is only extended after this approval has been renewed.

This enables us to guarantee our customers that our top quality product(s) always meet the prescribed standards.

Graphic welding arc

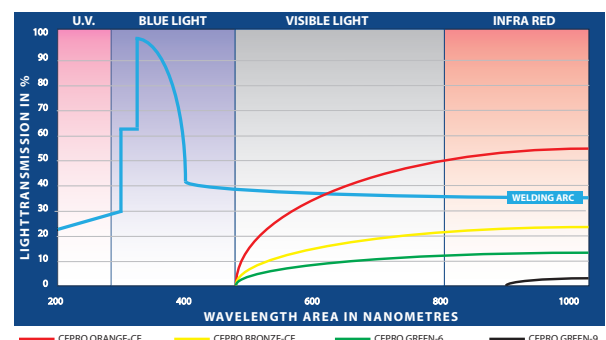

WELDING SCREENS

Robusto welding screen

CEPRO[®]
LEADING IN WELDING SAFETY

▶ ROBUSTO WELDING SCREEN

CEPRO Robusto welding screens are very high quality screens. Because they are solidly built they can be used in even the most demanding working conditions.

Unless otherwise stated, all CEPRO welding screens are available as follows:

- 210cm high
- The frame is made from a 35 x 2.5 mm round tube and a rectangular 50 x 30 x 2mm tube
- RAL7035 grey powder coating finish
- Provided with four Ø 75mm swivel castors, two with a brake

▶ Available models

- Single screen, 215cm wide
- Triptych screen, 215cm wide + 2 swivel arms each 70cm
- Triptych XL screen, 215cm wide + 2 swivel arms each 110cm

▶ Technical information

- The CEPRO Robusto welding screen is supplied as an assembly kit in a strong cardboard box.
- CEPRO Robusto welding screens are designed for indoor use
- The nuts and bolts used to connect the frame should be checked regularly
- You should regularly check the CEPRO Robusto welding screen for tears and/or other damage. Replace damaged curtains or strips if necessary.

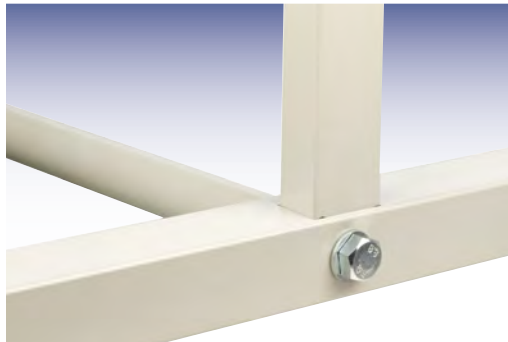
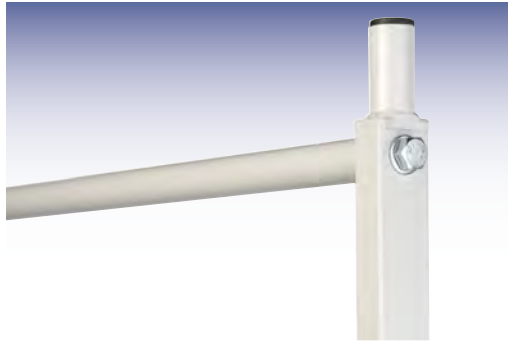

▶ CEPRO ROBUSTO WELDING SCREEN 215CM

- Height 210 cm
- Width central section 215cm
- Standard 4 swivel castors Ø 75mm
- 2 swivel castors with brake and 2 without
- RAL 7035 powder coating finish
- Round 35 x 2.5mm tube
- Rectangular 50 x 30 x 2mm tube



▶ WITH CURTAINS

- Curtain height 180cm
- Plastic suspension rings
- Curtains EN-1598 approved

Robusto Single screen with Cepro Orange-CE curtain	36.32.15
Robusto Single screen with Cepro Green-9 curtain	36.32.19
Robusto Single screen with Cepro Green-6 curtain	36.32.16
Robusto Single screen with Cepro Bronze-CE curtain	36.32.17

REPLACEMENT CURTAINS

Cepro Orange-CE replacement curtain complete set	18.15.18
Cepro Green-9 replacement curtain complete set	18.19.18
Cepro Green-6 replacement curtain complete set	18.16.18
Cepro Bronze-CE replacement curtain complete set	18.17.18



▶ WITH STRIPS

- Strips height 180cm
- Strips 300 x 2mm
- Overlap strips 10cm
- Plastic suspension clips
- Strips EN-1598 approved

Robusto Single screen with Cepro Orange-CE strips	36.32.25
Robusto Single screen with Cepro Green-9 strips	36.32.29
Robusto Single screen with Cepro Green-6 strips	36.32.26
Robusto Single screen with Cepro Bronze-CE strips	36.32.27

REPLACEMENT STRIPS

Cepro Orange-CE replacement strips complete set	29.05.18.0010
Cepro Green-9 replacement strips complete set	29.09.18.0010
Cepro Green-6 replacement strips complete set	29.06.18.0010
Cepro Bronze-CE replacement strips complete set	29.07.18.0010



▶ SPECIALS

- Curtain height 180cm
- Atlas curtain 550 °C
- Sonic curtain Rw= 14 dB

Robusto Single screen with Cepro Atlas heat resistant curtain	36.32.31
Robusto Single screen with Cepro Sonic sound absorbing curtain	36.32.45

REPLACEMENT CURTAINS

Cepro Atlas replacement curtain complete set	59.01.10.0003
Cepro Sonic replacement curtain complete set	92.15.01

▶ CEPRO ROBUSTO TRIPTYCH WELDING SCREEN 355CM

- Height 210 cm
- Width central section 215cm
- 2 swivel arms each 70cm
- Standard 4 swivel castors Ø 75mm
- 2 swivel castors with brake and 2 without
- RAL 7035 powder coating finish
- Round 35 x 2.5mm tube
- Rectangular 50 x 30 x 2mm tube



▶ WITH CURTAINS

- Curtain height 180cm
- Plastic suspension rings
- Curtains EN-1598 approved

- Robusto Triptych screen with Cepro Orange-CE curtain **36.31.15**
- Robusto Triptych screen with Cepro Green-9 curtain **36.31.19**
- Robusto Triptych screen with Cepro Green-6 curtain **36.31.16**
- Robusto Triptych screen with Cepro Bronze-CE curtain **36.31.17**

REPLACEMENT CURTAINS

- Cepro Orange-CE replacement curtain complete set **18.15.18.0001**
- Cepro Green-9 replacement curtain complete set **18.19.18.0001**
- Cepro Green-6 replacement curtain complete set **18.16.18.0001**
- Cepro Bronze-CE replacement curtain complete set **18.17.18.0001**



▶ WITH STRIPS

- Strips height 180cm
- Strips 300 x 2mm
- Overlap strips 10cm
- Plastic suspension clips
- Strips EN-1598 approved

- Robusto Triptych screen with Cepro Orange-CE strips **36.31.25**
- Robusto Triptych screen with Cepro Green-9 strips **36.31.29**
- Robusto Triptych screen with Cepro Green-6 strips **36.31.26**
- Robusto Triptych screen with Cepro Bronze-CE strips **36.31.27**

REPLACEMENT STRIPS

- Cepro Orange-CE replacement strips complete set **29.05.18.0016**
- Cepro Green-9 replacement strips complete set **29.09.18.0016**
- Cepro Green-6 replacement strips complete set **29.06.18.0016**
- Cepro Bronze-CE replacement strips complete set **29.07.18.0016**



▶ SPECIALS

- Curtain height 180cm
- Atlas curtain 550 °C
- Sonic curtain Rw= 14 dB

- Robusto Triptych screen with Cepro Atlas heat resistant curtain **36.31.31**
- Robusto Triptych screen with Cepro Sonic sound absorbing curtain **36.31.45**

REPLACEMENT CURTAINS

- Cepro Atlas replacement curtain complete set **59.01.10.0004**
- Cepro Sonic replacement curtain complete set **92.15.01**

▶ CEPRO ROBUSTO TRIPTYCH XL WELDING SCREEN 435CM

- Height 210 cm
- Width central section 215cm
- 2 swivel arms each 110cm
- Standard 4 swivel castors Ø 75mm
- 2 swivel castors with brake and 2 without
- RAL 7035 powder coating finish
- Round 35 x 2.5mm tube
- Rectangular 50 x 30 x 2mm tube



▶ WITH CURTAINS

- Curtain height 180cm
- Plastic suspension rings
- Curtains EN-1598 approved

Robusto Triptych XL screen with Cepro Orange-CE curtain	36.31.65
Robusto Triptych XL screen with Cepro Green-9 curtain	36.31.69
Robusto Triptych XL screen with Cepro Green-6 curtain	36.31.66
Robusto Triptych XL screen with Cepro Bronze-CE curtain	36.31.67

REPLACEMENT CURTAINS

Cepro Orange-CE replacement curtain complete set	18.15.18.0002
Cepro Green-9 replacement curtain complete set	18.19.18.0002
Cepro Green-6 replacement curtain complete set	18.16.18.0002
Cepro Bronze-CE replacement curtain complete set	18.17.18.0002



▶ WITH STRIPS

- Strips height 180cm
- Strips 300 x 2mm
- Overlap strips 10cm
- Plastic suspension clips
- Strips EN-1598 approved

Robusto Triptych XL screen with Cepro Orange-CE strips	36.31.75
Robusto Triptych XL screen with Cepro Green-9 strips	36.31.79
Robusto Triptych XL screen with Cepro Green-6 strips	36.31.76
Robusto Triptych XL screen with Cepro Bronze-CE strips	36.31.77

REPLACEMENT STRIPS

Cepro Orange-CE replacement strips complete set	29.05.18.0020
Cepro Green-9 replacement strips complete set	29.09.18.0020
Cepro Green-6 replacement strips complete set	29.06.18.0020
Cepro Bronze-CE replacement strips complete set	29.07.18.0020



▶ SPECIALS

- Curtain height 180cm
- Atlas curtain 550 °C
- Sonic curtain Rw= 14 dB

Robusto Triptych XL screen with Cepro Atlas heat resistant curtain	36.31.81
Robusto Triptych XL screen with Cepro Sonic sound absorbing curtain	36.31.95

REPLACEMENT CURTAINS

Cepro Atlas replacement curtain complete set	59.01.10.0005
Cepro Sonic replacement curtain complete set	92.15.01

► CEPRO ROBUSTO PARTS

- Parts for Robusto screen
- Castors Ø 75 mm
- Round 35 x 2,5 mm tube
- Rectangular 50 x 30 x 2mm tube



► CASTORS

- Ø 75mm

Castor for Robusto welding screen
with break Ø 75 mm **30.04.32.01**

Castor for Robusto welding screen
without break Ø 75 mm **30.04.32.00**



► SWIVEL ARM 70CM

- Curtain / strips height 180cm
- Strips 300 x 2mm
- Overlap strips 10cm
- Plastic suspension clips for strips
- Plastic suspension rings for curtains
- Curtains / strips EN-1598 approved

Robusto swivel arm 70 cm,
without curtain/strips **30.01.32.07**

Wall hinge for Robusto screen
swivel arm **80.10.08**

SWIVEL ARM WITH CURTAINS

Robusto swivel arm 70 cm
Orange-CE curtain **30.01.32.0715**

Robusto swivel arm 70 cm
Green-9 curtain **30.01.32.0719**

Robusto swivel arm 70 cm
Green-6 curtain **30.01.32.0716**

Robusto swivel arm 70 cm
Bronze-CE curtain **30.01.32.0717**

SWIVEL ARM WITH STRIPS

Robusto swivel arm 70 cm
Orange-CE strips **30.01.32.0725**

Robusto swivel arm 70 cm
Green-9 strips **30.01.32.0729**

Robusto swivel arm 70 cm
Green-6 strips **30.01.32.0726**

Robusto swivel arm 70 cm
Bronze-CE strips **30.01.32.0727**



► SWIVEL ARM 110 CM

- Curtain / strips height 180cm
- Strips 300 x 2mm
- Overlap strips 10cm
- Plastic suspension clips for strips
- Plastic suspension rings for curtains
- Curtains / strips EN-1598 approved

Robusto swivel arm 110 cm
without curtain/strips **30.01.32.11**

Wall hinge for Robusto screen
swivel arm **80.10.08**

SWIVEL ARM WITH CURTAINS

Robusto swivel arm 110 cm
Orange-CE curtain **30.01.32.1115**

Robusto swivel arm 110 cm
Green-9 curtain **30.01.32.1119**

Robusto swivel arm 110 cm
Green-6 curtain **30.01.32.1116**

Robusto swivel arm 110 cm
Bronze-CE curtain **30.01.32.1117**

SWIVEL ARM WITH STRIPS

Robusto swivel arm 110 cm
Orange-CE strips **30.01.32.1125**

Robusto swivel arm 110 cm
Green-9 strips **30.01.32.1129**

Robusto swivel arm 110 cm
Green-6 strips **30.01.32.1126**

Robusto swivel arm 110 cm
Bronze-CE strips **30.01.32.1127**

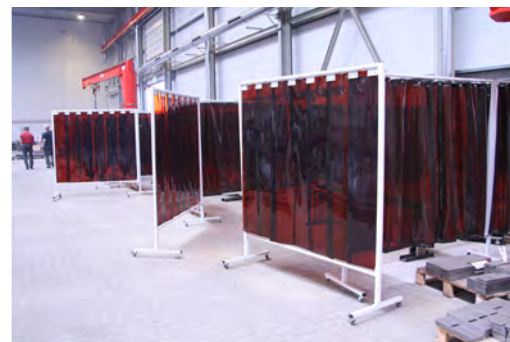

OMNIUM WELDING SCREEN

CEPRO Omnium welding screens are sturdy and stylish. The CEPRO Omnium welding screen is an all-round welding screen and often used in difficult working conditions.

Unless otherwise stated, all CEPRO welding screens are available as follows:

- 200cm high
- The frame is made from a round 30 x 2mm tube and a 40 x 30 x 2mm rectangular tube
- RAL7035 grey powder coating finish
- Provided with 4 swivel castors Ø 50mm, 2 with a brake

Available models

- Single screen, 215cm wide
- Triptych screen, 215cm wide + 2 swivel arms 80cm each
- Triptych XL screen, 215cm wide + 2 swivel arms 110cm each

Technical information

- The CEPRO Omnium welding screen is supplied as an assembly kit in a strong cardboard box.
- CEPRO Omnium welding screens are designed for indoor use
- The nuts and bolts used to connect the frame should be checked regularly
- You should regularly check the CEPRO Omnium welding screen for tears and/or other damage. Replace damaged curtains or strips if necessary.

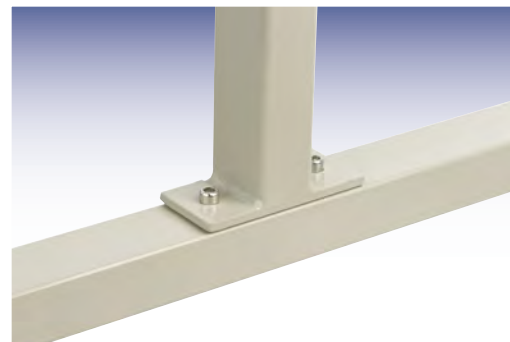
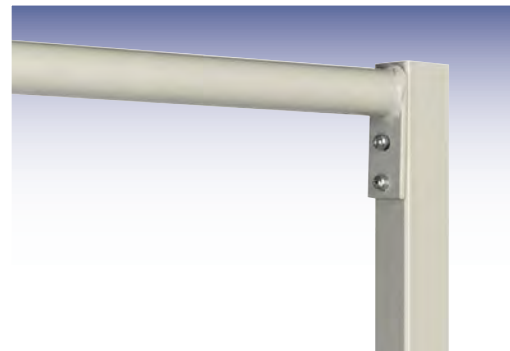

▶ **CEPRO OMNIUM WELDING SCREEN 215CM**

- Height 200 cm
- Width central section 215cm
- Standard 4 swivel castors 50mm Ø
- 2 swivel castors with brake and 2 without
- RAL 7035 powder coating finish
- Round 30 x 2mm tube
- Rectangular 40 x 30 x 2mm tube



▶ **WITH CURTAINS**

- Curtain height 160cm
- Plastic suspension rings
- Curtains EN-1598 approved

Omnium Single screen with Cepro Orange-CE curtain	36.34.15
Omnium Single screen with Cepro Green-9 curtain	36.34.19
Omnium Single screen with Cepro Green-6 curtain	36.34.16
Omnium Single screen with Cepro Bronze-CE curtain	36.34.17

REPLACEMENT CURTAINS

Cepro Orange-CE replacement curtain complete set	18.15.16
Cepro Green-9 replacement curtain complete set	18.19.16
Cepro Green-6 replacement curtain complete set	18.16.16
Cepro Bronze-CE replacement curtain complete set	18.17.16



▶ **WITH STRIPS**

- Strip height 160cm
- Strips 300 x 2mm
- Overlap strips 5cm
- Plastic suspension clips
- Strips EN-1598 approved

Omnium Single screen with Cepro Orange-CE strips	36.34.25
Omnium Single screen with Cepro Green-9 strips	36.34.29
Omnium Single screen with Cepro Green-6 strips	36.34.26
Omnium Single screen with Cepro Bronze-CE strips	36.34.27

REPLACEMENT STRIPS

Cepro Orange-CE replacement strips complete set	29.05.16.0008
Cepro Green-9 replacement strips complete set	29.09.16.0008
Cepro Green-6 replacement strips complete set	29.06.16.0008
Cepro Bronze-CE replacement strips complete set	29.07.16.0008



▶ **WITH SHEET**

- Sheet height 160cm
- Sheets 570 x 1mm
- Metal tube clamps
- Sheet EN-1598 approved

Omnium Single screen with Cepro Orange-CE sheet	36.34.05
Omnium Single screen with Cepro Green-9 sheet	36.34.09
Omnium Single screen with Cepro Green-6 sheet	36.34.06
Omnium Single screen with Cepro Bronze-CE sheet	36.34.07

REPLACEMENT SHEETS

Cepro Orange-CE replacement sheets complete set	22.15.16.0004
Cepro Green-9 replacement sheets complete set	22.19.16.0004
Cepro Green-6 replacement sheets complete set	22.16.16.0004
Cepro Bronze-CE replacement sheets complete set	22.17.16.0004

▶ CEPRO OMNIUM TRIPTYCH WELDING SCREEN 375CM

- Height 200cm
- Width central section 215cm
- 2 swivel arms each 80cm
- Standard 4 swivel castors 50mm Ø
- 2 swivel castors with brake and 2 without
- RAL 7035 powder coating finish
- Round 30 x mm tube
- Rectangular 40 x 30 x 2mm tube



▶ WITH CURTAINS

- Curtain height 160cm
- Plastic suspension rings
- Curtains EN-1598 approved

Omnium Triptych screen with Cepro Orange-CE curtain	36.36.15
Omnium Triptych screen with Cepro Green-9 curtain	36.36.19
Omnium Triptych screen with Cepro Green-6 curtain	36.36.16
Omnium Triptych screen with Cepro Bronze-CE curtain	36.36.17

REPLACEMENT CURTAINS

Cepro Orange-CE replacement curtain complete set	18.15.16.0001
Cepro Green-9 replacement curtain complete set	18.19.16.0001
Cepro Green-6 replacement curtain complete set	18.16.16.0001
Cepro Bronze-CE replacement curtain complete set	18.17.16.0001



▶ WITH STRIPS

- Strip height 160cm
- Strips 300 x 2mm
- Overlap strips 5cm
- Plastic suspension clips
- Strips EN-1598 approved

Omnium Triptych screen with Cepro Orange-CE strips	36.36.25
Omnium Triptych screen with Cepro Green-9 strips	36.36.29
Omnium Triptych screen with Cepro Green-6 strips	36.36.26
Omnium Triptych screen with Cepro Bronze-CE strips	36.36.27

REPLACEMENT STRIPS

Cepro Orange-CE replacement strips complete set	29.05.16.0014
Cepro Green-9 replacement strips complete set	29.09.16.0014
Cepro Green-6 replacement strips complete set	29.06.16.0014
Cepro Bronze-CE replacement strips complete set	29.07.16.0014



▶ WITH SHEET

- Sheet height 160cm
- Sheets 570 x 1mm
- Metal tube clamps
- Sheet EN-1598 approved

Omnium Triptych screen with Cepro Orange-CE sheet	36.36.05
Omnium Triptych screen with Cepro Green-9 sheet	36.36.09
Omnium Triptych screen with Cepro Green-6 sheet	36.36.06
Omnium Triptych screen with Cepro Bronze-CE sheet	36.36.07

REPLACEMENT SHEET

Cepro Orange-CE replacement sheet complete set	2 x 22.15.16.0004
Cepro Green-9 replacement sheet complete set	2 x 22.19.16.0004
Cepro Green-6 replacement sheet complete set	2 x 22.16.16.0004
Cepro Bronze-CE replacement sheet complete set	2 x 22.17.16.0004

▶ **CEPRO OMNIUM TRIPTYCH XL WELDING SCREEN 435CM**

- Height 200cm
- Width central section 215cm
- 2 swivel arms each 110cm
- Standard 4 swivel castors Ø 50mm
- 2 swivel castors with brake and 2 without
- RAL 7035 powder coating finish
- Round 30 x 2mm tube
- Rectangular 40 x 30 x 2mm tube



▶ **WITH CURTAINS**

- Curtain height 160cm
- Plastic suspension rings
- Curtains EN-1598 approved

Omnium Triptych XL screen with Cepro Orange-CE curtain	36.36.65
Omnium Triptych XL screen with Cepro Green-9 curtain	36.36.69
Omnium Triptych XL screen with Cepro Green-6 curtain	36.36.66
Omnium Triptych XL screen with Cepro Bronze-CE curtain	36.36.67

REPLACEMENT CURTAINS

Cepro Orange-CE replacement curtain complete set	18.15.16.0002
Cepro Green-9 replacement curtain complete set	18.19.16.0002
Cepro Green-6 replacement curtain complete set	18.16.16.0002
Cepro Bronze-CE replacement curtain complete set	18.17.16.0002

▶ CEPRO OMNIUM PARTS

- Parts for Omnium screen
- Castors 50mm Ø
- Round 30 x 2mm tube
- Rectangular 40 x 30 x 2mm tube

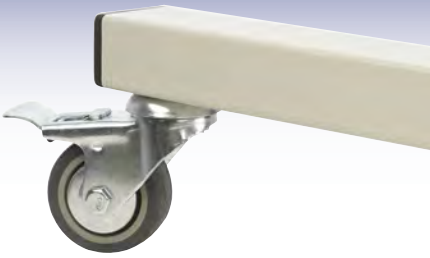

▶ CASTORS

- Ø 50 mm

Castor for Omnium screen
with brake 50mm Ø **30.04.34.01**

Castor for Omnium screen
without brake 50mm Ø **30.04.34.00**



▶ SWIVEL ARM 80CM

- Curtain / strips height 160cm
- Strips 300 x 2mm
- Overlap strips 5cm
- Plastic suspension clips for strips
- Plastic suspension rings for curtains
- Curtains / strips EN-1598 approved

Omnium swivel arm 80cm
without curtain / strips **30.01.34.08**

Hinge for fitting swivel arm to
Omnium screen **30.03.34**

SWIVEL ARM WITH CURTAINS

Omnium swivel arm 80cm
Orange-CE curtain **30.01.34.0815**

Omnium swivel arm 80cm
Green-9 curtain **30.01.34.0819**

Omnium swivel arm 80cm
Green-6 curtain **30.01.34.0816**

Omnium swivel arm 80cm
Bronze-CE curtain **30.01.34.0817**

SWIVEL ARM WITH STRIPS

Omnium swivel arm 80cm
Orange-CE strips **30.01.34.0825**

Omnium swivel arm 80cm
Green-9 strips **30.01.34.0829**

Omnium swivel arm 80cm
Green-6 strips **30.01.34.0826**

Omnium swivel arm 80cm
Bronze-CE strips **30.01.34.0827**



▶ SWIVEL ARM 110CM

- Curtain / strips height 160cm
- Plastic suspension clips for strips
- Plastic suspension rings for curtains
- Curtains / strips EN-1598 approved

Omnium swivel arm 110cm
without curtain / strips **30.01.32.11**

Hinge for fitting swivel arm to
Omnium screen **30.03.34**

SWIVEL ARM WITH CURTAINS

Omnium swivel arm 110cm
Orange-CE curtain **30.01.34.1115**

Omnium swivel arm 110cm
Green-9 curtain **30.01.34.1119**

Omnium swivel arm 110cm
Green-6 curtain **30.01.34.1116**

Omnium swivel arm 110cm
Bronze-CE curtain **30.01.34.1117**





▶ SPRINT WELDING SCREEN

CEPRO Sprint welding screens are quality-made screens. The CEPRO Sprint welding screen can be used in diverse working conditions.

Unless otherwise stated, all CEPRO welding screens are available as follows:

- 193cm high
- The frame is made from a round galvanized 22 x1mm tube and a square 30 x 30 x 2mm tube
- RAL3020 red powder coating finish (uprights and supports)

▶ Available models

- Single screen, 192cm wide

▶ Technical information

- The CEPRO Sprint welding screen is supplied as an assembly kit in a strong cardboard box.
- CEPRO Sprint welding screens are designed for indoor use
- The nuts and bolts used to connect the frame should be checked regularly
- You should regularly check the CEPRO Sprint welding screen for tears and/or other damage. Replace damaged curtains or sheets if necessary.

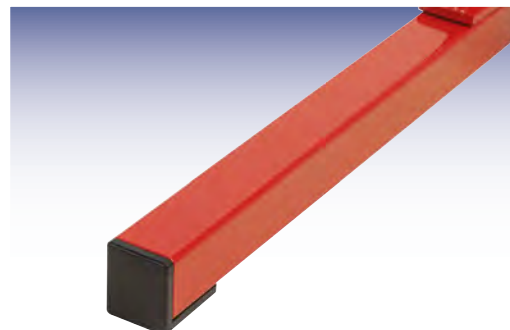
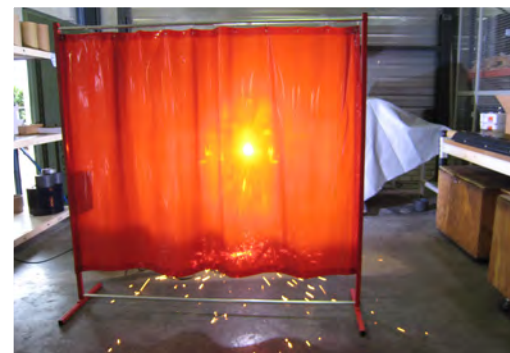
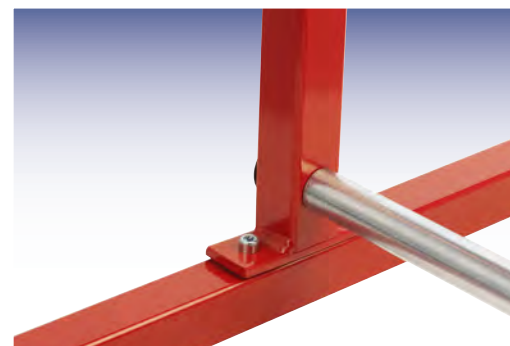
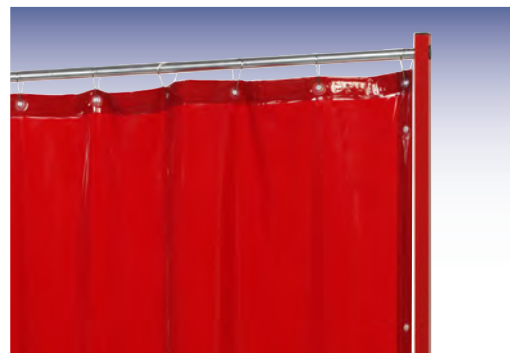
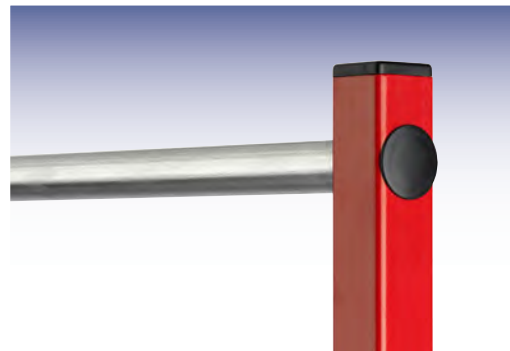

▶ CEPRO SPRINT WELDING SCREEN

- Height 193cm
- Width 192cm
- Without castors (optional)
- RAL 3020 powder coating finish
- Round galvanized 22 x 1mm tube
- Square 30 x 30 x 2mm tube



▶ WITH CURTAINS

- Curtain height 160cm
- Steel suspension rings
- Curtains EN-1598 approved

Sprint Single screen with Cepro Orange-CE curtain	36.38.15
Sprint Single screen with Cepro Green-9 curtain	36.38.19
Sprint Single screen with Cepro Green-6 curtain	36.38.16
Sprint Single screen with Cepro Bronze-CE curtain	36.38.17

REPLACEMENT CURTAINS

Cepro Orange-CE replacement curtain complete set	18.15.16
Cepro Green-9 replacement curtain complete set	18.19.16
Cepro Green-6 replacement curtain complete set	18.16.16
Cepro Bronze-CE replacement curtain complete set	18.17.16



▶ WITH SHEET

- Sheet height 160cm
- Sheets 570 x 1mm
- Metall tube clamps
- Sheet EN-1598 approved

Sprint Single screen with Cepro Orange-CE sheet	36.38.05
Sprint Single screen with Cepro Green-9 sheet	36.38.09
Sprint Single screen with Cepro Green-6 sheet	36.38.06
Sprint Single screen with Cepro Bronze-CE sheet	36.38.07

REPLACEMENT STRIPS

Cepro Orange-CE replacement sheet complete set	22.15.16.0004
Cepro Green-9 replacement sheet complete set	22.19.16.0004
Cepro Green-6 replacement sheet complete set	22.16.16.0004
Cepro Bronze-CE replacement sheet complete set	22.17.16.0004



▶ CASTORS

- Ø 50mm

Set castors for Sprint screen	30.06.34
-------------------------------	-----------------

REPLACEMENT CASTORS

Castor for Sprint screen with brake 50mm Ø	30.04.34.01
Castor for Sprint screen without brake 50 mm Ø	30.04.34.00



▶ GAZELLE WELDING SCREEN

CEPRO Gazelle welding screens are ideal for use in smaller workspaces and infrequent use. They are very lightweight and can be easily moved by hand.

Unless otherwise stated, all CEPRO welding screens are available as follows:

- 200cm high.
- Made from a round galvanized 25 x 1mm tube
- Provided with a tension curtain with an upper and lower open seam
- Packed in a cardboard box measuring only 120cm therefore easy to send through the regular parcel services

▶ Available models

- Single screen, 200cm wide
- Single screen, 140cm wide

▶ Technical information

- The CEPRO Gazelle welding screen is supplied as an assembly kit in a strong cardboard box.
- CEPRO Gazelle welding screens are designed for indoor use
- The nuts and bolts used to connect the frame should be checked regularly
- You should regularly check the CEPRO Gazelle welding screen for tears and/or other damage. Replace damaged curtains if necessary.

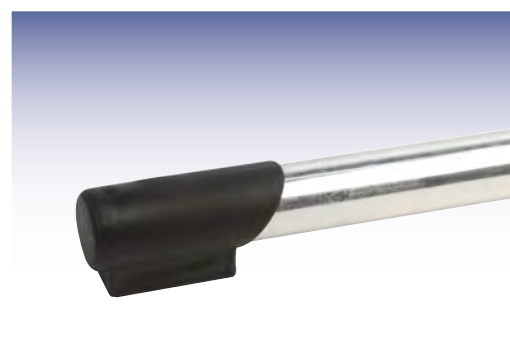

▶ CEPRO GAZELLE WELDING SCREEN

- Height 200 cm
- Width 200cm / 140cm
- Without castors
- Galvanized frame
- Round 25 x 1mm tube
- Fitted with a curtain with an open seam on the top and bottom



▶ 140 CM WIDE

- Curtain height 170cm
- Fitted curtain with an open seam at the top and bottom
- Curtains EN-1598 approved

Gazelle screen with Cepro Orange-CE curtain	36.39.15
Gazelle screen with Cepro Green-9 curtain	36.39.19
Gazelle screen with Cepro Green-6 curtain	36.39.16
Gazelle screen with Cepro Bronze-CE curtain	36.39.17

REPLACEMENT CURTAINS

Cepro Orange-CE replacement curtain 170 x 140cm	13.15.04.14
Cepro Green-9 replacement curtain 170 x 140cm	13.19.04.14
Cepro Green-6 replacement curtain 170 x 140cm	13.16.04.14
Cepro Bronze-CE replacement curtain 170 x 140cm	13.17.04.14



▶ 200 CM WIDE

- Curtain height 170cm
- Fitted curtain with an open seam at the top and bottom
- Curtains EN-1598 approved

Gazelle screen with Cepro Orange-CE curtain	36.39.25
Gazelle screen with Gazelle Green-9 curtain	36.39.29
Gazelle screen with Cepro Green-6 curtain	36.39.26
Gazelle screen with Cepro Bronze-CE curtain	36.39.27

REPLACEMENT CURTAINS

Cepro Orange-CE replacement curtain 170 x 200cm	13.15.04.20
Cepro Green-9 replacement curtain 170 x 200cm	13.19.04.20
Cepro Green-6 replacement curtain 170 x 200cm	13.16.04.20
Cepro Bronze-CE replacement curtain 170 x 200cm	13.17.04.20



CEPRO®

LEADING IN WELDING SAFETY



Maahantuonti ja markkinointi

Teknoexpertit Oy

Teknoexpertit Oy

Kapanalhonpolku 4, FI-20400 Turku

Puh. 0207 597 999

www.teknoexpertit.fi



WELDING
CURTAINS



WELDING
BLANKETS



WELDING
SCREENS
Ref. 96.21.33



WELDING BOOTHS
GRINDING BOOTHS



OUTDOOR
WELDING



CONSTRUCTION